



IP CAMERA

User Manual

IV-BUF362MP (MINI IR Bullet)

V1.2

PRECAUTIONS

- **Do not use the camera in extreme temperature conditions.**

Please use the camera within 14°F to 122°F

Air vent is required at high temperature

- **Do not use or store the camera in humid environment**

It may cause poor image quality.

- **Do not use the camera in unstable lighting conditions.**

Inconsistent lighting or flickering may cause poor image.

- **Never use the camera close to gas or oil leak.**

It may not operate properly.

- **Do not disassemble the camera.**

There is no user serviceable part inside.

- **Do not drop the camera or apply force on it.**

It may cause a malfunction.

- **Never face the camera to strong light for long periods of time.**

It may damage the CMOS sensor.

When this camera is installed near wireless communication devices that emits strong electromagnetic field, irregularity such as noise may appear in the image.

1. N-CASE INSPECTION

1.1 Check step

When a user receives a IP camera, Please check the equipment appearance without obvious damage. Product packaging use protective material to deal with most accidental impact in the transport process.

Please open the product outer packing, Check attachment provided product is complete, See List 1 below accessories package for inspection.

1.2 Standard accessories

Please make sure the item is consistent with the listing when open the product outer packing, Detailed list please see the table below, Actual configuration, please refer to specific products.

List 1 Accessories list

Name	Units	Quantity
IP camera	pcs	1
User Manual	pcs	1
Accessory pack	pcs	1
CD	pcs	1

2. PRODUCT STRUCTURE

2.1 Cable function

Picture 1 Cable function



List 2 Cable function of table

NO.	Name	Functional description
1	Power	DC12V power input
2	LAN(RJ45)	Connect to a router or switch on your network using RJ45 Ethernet cable (Cat5e or better). 100Mhz connection. PoE supported (class 3 PoE switch required).

2.2 Dimensions

Picture 2 Dimensions

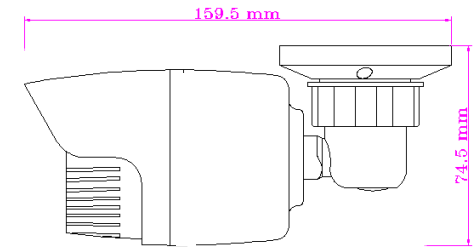
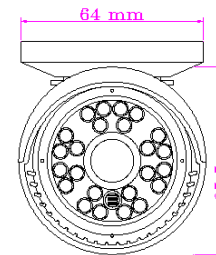

3. EQUIPMENT INSTALLATION

Picture 3 Equipment installation diagram (1)

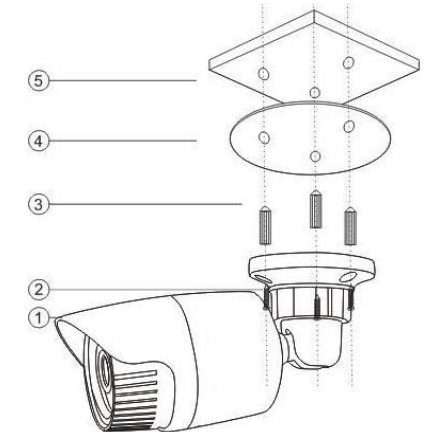

NO.	Name
1	IP Camera
2	Mounting Screw
3	Expansion bolt
4	Sticker
5	Wall or Ceiling

Description: bracket installation metope, need to withstand at least 3X the total weight of the bracket and the camera

3.1 Put stickers to the surface where need to be installed (Wall or Ceiling) ;

3.2 Carried out in accordance with the installation sticker above marked the location of the hole;

- 3.3 Open the accessory pack, take out expansion bolt, expansion bolt nail into drilled holes inside;
- 3.4 Open the attachment pack, take out the screws; With this screw will play good expansion bolt installation device fixed to the surface (wall or ceiling);
- 3.5 Plug the external cables according to the use requirements of equipment.

Picture 4 Equipment installation diagram(2)

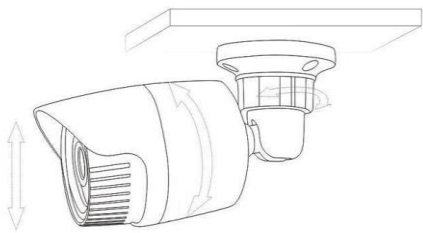

- 3.6 Using tools to adjust screw loose device;
- 3.7 The up and down or so regulating equipment, according to the use requirements set equipment of direction;
- 3.8 Using tools to screw locking device;

4. Network Operation

- 4.1 Use correct power supply
- 4.2 After startup, connect the device with switch or router, see below picture

Picture 5 Network structure



- 4.3 Make default IP address is 192.168.1.10
- 4.4 Go to CD->English->Software to find UpgradeTool and install it.
- 4.5 Run UpgradeTool, Click "IP Search", you will find the device ip, see below picture

Picture 6 IP Configure

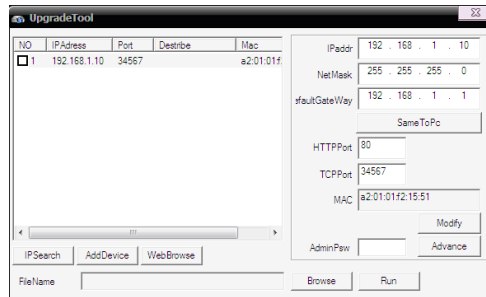

- 4.6 Select the device to config IP, see below picture

Picture 7 IP Configure

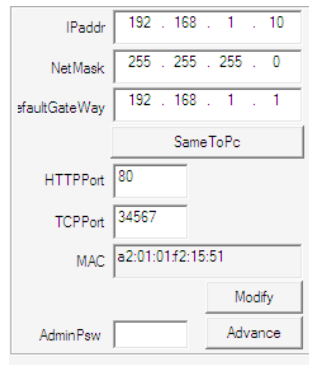

- 4.7 Default IP setting:

IP address: 192.168.1.10
 Subnet Mask: 255.255.255.0
 Gateway: 192.168.1.1
 User name: admin
 Password: no password

- 4.8 Open IE, type IP address, login with user name and password, see below picture.

Picture 8 WEB GUI After login, enter into below picture

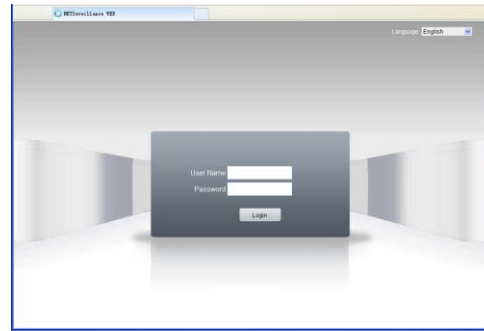

- 4.9 Login with user name and password, see below picture

Picture 9 Bit rate type

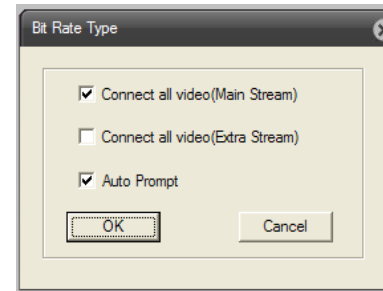

Picture 10 WEB GUI after login



Equipment specific relevant parameter Settings please refer to IP camera user manual in the CD "IPC Fast User Manual.pdf" and "IP Camera user manual_Common Version.pdf".

5. SPECIFICATIONS

Model	IV-BUF3612MP	
Camera		
Image Sensor	1/3" 1.3Megapixel Sony Exmor	
Effective Pixels	1920(H)x 1080(V)	
Scanning System	Progressive	
Electronic Shutter Speed	Auto/Manual 1/50~1/10000	
Min. Illumination	Color: 0.1 lux /F1.4, B/W: 0.01 lux /F1.4.0 lux (IR on)	
S/N Ratio	>50dB	
Camera Features		
Max. IR LEDs Length	60 ft	
Day/Night	Auto(ICR) / Color / B/W	
Backlight	BLC	
White Balance	Auto	
Gain Control	Auto/Manual	
Noise Reduction	3D	
Privacy Masking	Up to 4 areas	
Slow Shutter	None / Low / Middle / High	
Motion Detection	22X18 areas	
Lens		
Focal Length	3.6mm	
Max Aperture	F2.0	
Mount Type	Board-in Type	
Video		
Compression	H.264 High Profile / JPEG Snapshot	
Resolution	60Hz Mode: 960P(1280x960) / 720P(1280x720) / D1(704X480) / CIF(352X240)	
Frame Rate	Main Stream	1920 x 1080 (1 ~ 25/30fps)
	Sub Stream	704 x 576 (1 ~ 25/30fps)
Bit Rate	H.264: 64K ~ 4096Kbps	
Network		
Ethernet	RJ-45 (10/100Base-T)	
Protocol	IPv4, HTTP, SSL, TCP/IP, UDP, UPnP, ICMP, IGMP, SNMP, RTSP, RTP, SMTP, NTP, DHCP, DNS, PPPOE, DDNS, FTP, IP Filter, QoS, Cloud	
ONVIF	ONVIF Ver. 2.0	
Max. User Access	5 users	
Smart Phones	iPhone, Windows Mobile, BlackBerry, Symbian, Android	
Browsers	IE, Chrome, Firefox, Safari	
General		
Power Supply	DC12V, PoE (802.3af)	
Power Consumption	<10W	
Working Environment	Temperature: 14°F~140°F, Humidity: 10%~90%	
Ingress Protection	IP66	
Dimensions	6.28" x 2.93"	
Weight	1.15 lbs	

The Specifications are subject to change without prior notice.