

IP CAMERA

User Manual

IV-BU28122MP

(IR Bullet)

M Series V1.1

PRECAUTIONS

- Do not use the camera in extreme temperature conditions.

Please use the camera within -10°C to 50 °C

Air vent is required at high temperature

- Do not use or store the camera in humid environment

It may cause poor image quality.

- Do not use the camera in unstable lighting conditions.

Inconsistent lighting or flickering may cause poor image.

- Never use the camera close to gas or oil leak.

It may not operate properly.

- Do not disassemble the camera.

There is no user serviceable part inside.

- Do not drop the camera or apply force on it.

It may cause a malfunction.

- Never face the camera to strong light for long periods of time.

It may damage the CMOS sensor.

When this camera is installed near wireless communication devices that emits strong electromagnetic field, irregularity such as noise may appear in the image.

1. OPEN-CASE INSPECTION

1.1 Check step

When a user receives a IP camera, Please check the equipment appearance without obvious damage. Product packaging use protective material to deal with most accidental impact in the transport process.

Please open the product outer packing, Check attachment provided product is complete, See List 1 below accessories package for inspection.

1.2 Standard accessories

Please make sure the item is consistent with the listing when open the product outer packing, Detailed list please see the table below, Actual configuration, please refer to specific products.

List 1 Accessories list

Name	Units	Quantity
IP camera	pcs	1
User Manual	pcs	1
Accessory pack	pcs	1
CD	pcs	1

2. PRODUCT STRUCTURE

2.1 Cable function

Picture 1 Cable function



List 2 Cable function of table

NO.	Name	Functional description
1	LAN	Connect to a router or switch on your network using RJ45 Ethernet cable (Cat5e or better). 100Mhz connection. PoE supported (class 3 PoE switch required).
2	USB	Connect the WIFI or 3G equipment
3	Power	DC12V power input
4	Alarm	Two way alarm output
5	RS458	Connect to a RS485 cable.
6	/	/
7	Audio	2-way audio input output.

2.2 Dimensions

Picture 2 Dimensions

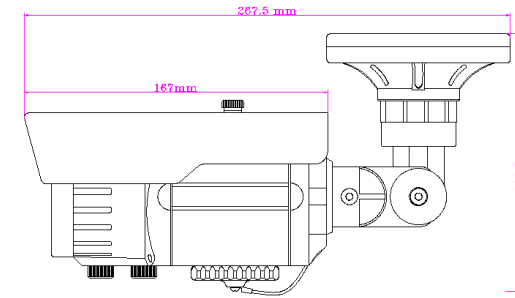
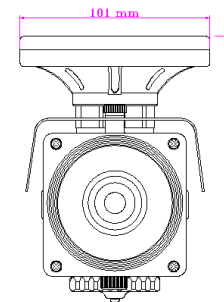

3. EQUIPMENT INSTALLATION

Picture 3 Equipment installation diagram (1)

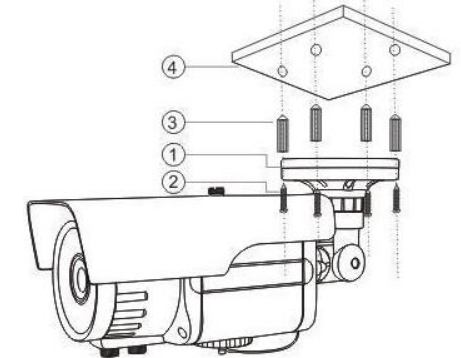

NO.	Name
1	IP Camera
2	Mounting Screw
3	Expansion bolt
4	Wall or Ceiling

Description: bracket installation metope, need to withstand at least 3X the total weight of the bracket and the camera

3.1 Put stickers to the surface where need to be installed (Wall or Ceiling) ;

3.2 Carried out in accordance with the installation sticker above marked the location of the hole;

- 3.3 Open the accessory pack, take out expansion bolt, expansion bolt nail into drilled holes inside;
- 3.4 Open the attachment pack, take out the screws; With this screw will play good expansion bolt installation device fixed to the surface (wall or ceiling);
- 3.5 Plug the external cables according to the use requirements of equipment.

Picture 4 Equipment installation diagram(2)

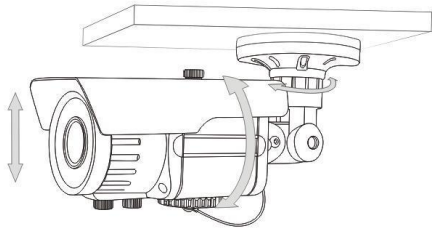

- 3.6 Using tools to adjust screw loose device;
- 3.7 The up and down or so regulating equipment, according to the use requirements set equipment of direction;

- 3.8 Using tools to screw locking device;

4.NETWORK OPERATION

- 4.1 Use correct power supply
- 4.2 After startup, connect the device with switch or router, see below picture

Picture 5 Network structure



- 4.3 Make default IP address is 192.168.1.10
- 4.4 Go to CD->English->Software to find UpgradeTool and install it.
- 4.5 Run UpgradeTool, Click "IP Search", you will find the device ip, see below picture

Picture 6 IP Configure

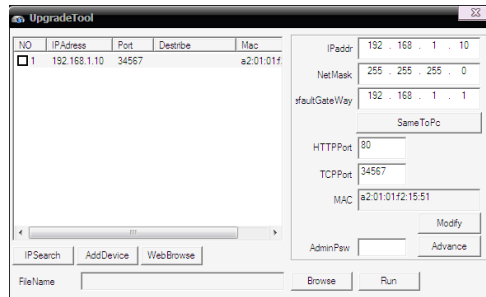

- 4.6 Select the device to config IP, see below picture

Picture 7 IP Configure

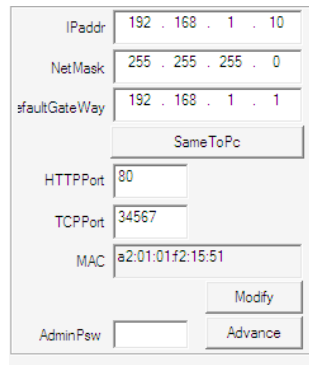

- 4.7 Default IP setting:

IP address: 192.168.1.10
 Subnet Mask: 255.255.255.0
 Gateway: 192.168.1.1
 User name: admin
 Password: no password

- 4.8 Open IE, type IP address, login with user name and password, see below picture.

Picture 8 WEB GUI After login, enter into below picture

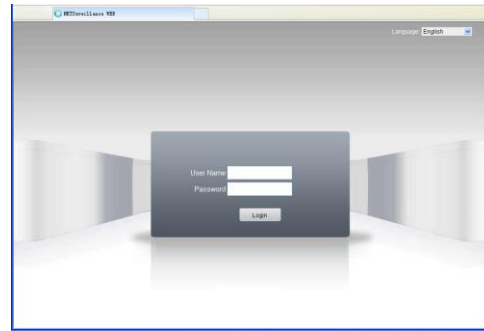

- 4.9 Login with user name and password, see below picture

Picture 9 Bit rate type

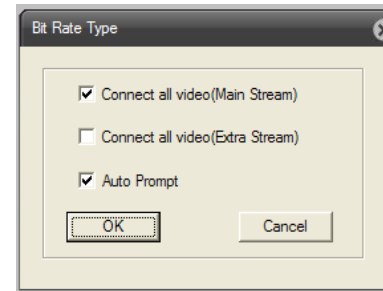

Picture 10 WEB GUI after login



Equipment specific relevant parameter Settings please refer to IP camera user manual in the CD "IPC Fast User Manual.pdf" and "IP Camera user manual_Common Version.pdf".

5.SPECIFICATIONS

Model	IV-BU28122MP
Camera	
Image Sensor	1/2.8" 2Megapixel Sony CMOS
Effective Pixels	1920(H)x1080(V)
Scanning System	Progressive
Electronic Shutter Speed	Auto/Manual 1/50~1/10000
Min. Illumination	Color: 0.1 lux /F1.4, B/W: 0.01 lux /F1.4, 0 lux (IR on)
S/N Ratio	>50dB
Camera Features	
Max. IR LEDs Length	105 ft
Day/Night	Auto(ICR) / Color / B/W
Backlight	BLC
White Balance	Auto
Gain Control	Auto/Manual
Noise Reduction	3D
Privacy Masking	Up to 4 areas
Slow Shutter	None / Low / Middle / High
Motion Detection	22X18 areas
Lens	
Focal Length	2.8-12mm
Max Aperture	F1.2
Mount Type	Board-in Type
Video	
Compression	H.264 High Profile / JPEG Snapshot
Resolution	60Hz Mode: 1080P(1920*1080) / 720P(1280*720) / D1(704X480) / CIF(352X240)
Frame Rate	Main Stream: 1080p (1 ~ 25 / 30fps) Sub Stream: D1/CIF(1 ~ 25/30fps)
Bit Rate	H.264: 64 K ~ 8192 Kbps
Network	
Ethernet	RJ-45 (10/100Base-T)
Protocol	IPv4, HTTP, SSL, TCP/IP, UDP, UPnP, ICMP, IGMP, SNMP, RTSP, RTP, SMTP, NTP, DHCP, DNS, PPPOE, DDNS, FTP, IP Filter, QoS, Cloud
ONVIF	ONVIF Ver. 2.0
Max. User Access	5 users
Smart Phones	iPhone, Windows Mobile, BlackBerry, Symbian, Android
Browsers	IE, Chrome, Firefox, Safari
General	
Power Supply	DC12V, PoE (802.3af)
Power Consumption	<6W
Working Environment	Temperature: 14°F~140°F, Humidity: 10%~90%
Ingress Protection	IP66
Dimensions	102.5" x 2.75"
Weight	3.20 lbs

The Specifications are subject to change without prior notice.